

H8
H8-P1-P2-BUSS

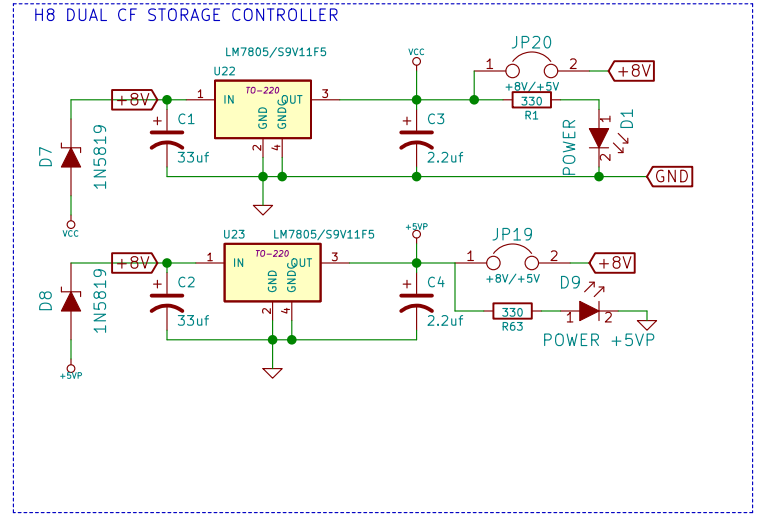

Sheet: H8-DUAL-CF-STORAGE

File: H8-DUAL-CF-STORAGE_Schematic.sch

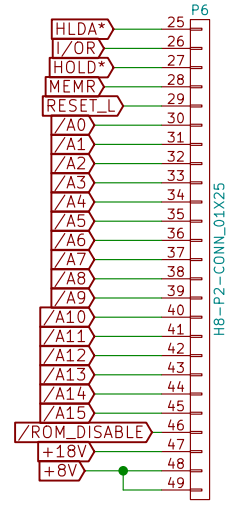

H8-P2-CONN_01X25

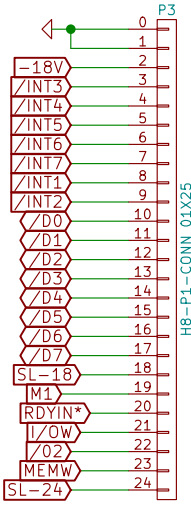

H8-P1-CONN_01X25

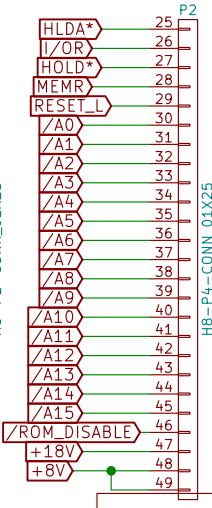

H8-P4-CONN_01X25

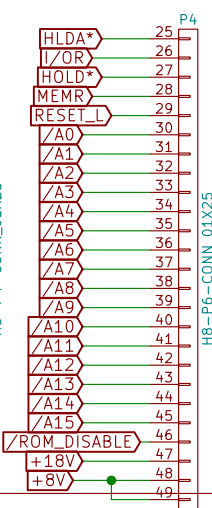

H8-P6-CONN_01X25

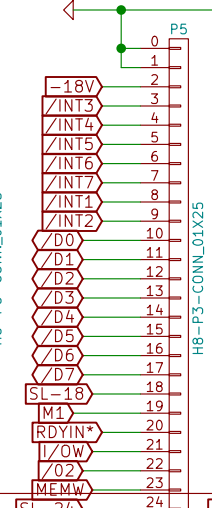

H8-P3-CONN_01X25

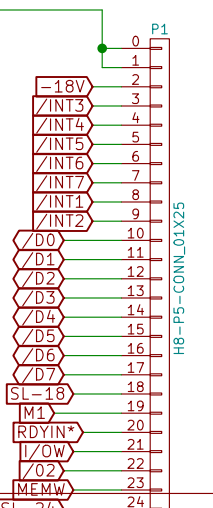

H8-P5-CONN_01X25

Copyright Norberto Collado © 2022
KOYADO.COM

Sheet: /
File: H8-DUAL-CF-STORAGE.sch

Title: H8-DUAL-CF-STORAGE

Size: A Date: 28 jul 2022
KiCad E.D.A. kicad (5.1.12)-1

Rev: 1.0
Id: 1/2

