



MAKE SAVINGS WITH HIGH STRENGTH STEEL

DILLIMAX

TECHNICAL INFORMATION NO. III/2007

DILLINGER HÜTTE GTS





April 2007



CONTENTS

4

Weight-Watching for your Steel Structures

6

The Manufacture of DILLIMAX

Melting the Steel
Shaping into Heavy Plate
Water Quenching

8

The Material Properties of DILLIMAX

Strength and Toughness
Properties in Through-Thickness Direction
High-Temperature Strength

12

The Processing of DILLIMAX

Cold Forming
Hot Forming
Forming within the Stress
Relieving Temperature Range
Thermal Cutting
Welding
Stress Relieving
Flame Straightening
Galvanizing
Machining

38

The Component Properties of DILLIMAX

44

Literature

46

Index



WEIGHT-WATCHING FOR YOUR STEEL STRUCTURES

The bearing capacity of steel structures such as crane booms, heavy utility vehicles chassis construction, steel constructions, flood gates or bridges is considerable. To demand that such structures also comply with the principle of light-gauge design – reduced use of material, good and easy machinability – would have been very difficult to achieve only a few years ago. Today, however, both of these requirements can be combined without any problems.

We would like to introduce to you a group of steels with which you can build structures with a high-load capacity and maximum of safety, and at the same time reduce material and fabrication costs by up to 50 %: DILLIMAX steels from DILLINGER HÜTTE GTS.

They are used by renowned manufacturers of construction and earth moving machinery, and have been used in the construction of many significant steel structures. One example to note is the Sony Center in Berlin, the impressive roof structure of which could be built using DILLIMAX 690 up to 180 mm thickness (see Figure 15, p. 27). These examples demonstrate the two most important aspects in



Figure 1: Crane booms of this length would not be conceivable without modern steels such as DILLIMAX (Illustration used with the kind permission of Demag Mobile Cranes GmbH, Zweibrücken, Germany)

the application of DILLIMAX: the intrinsic weight of constructions can be drastically reduced and, in addition, machines and vehicles are more manoeuvrable and consume less fuel.

DILLIMAX steels belong to the group of high-strength, weldable, fine-grained structural steels and possess both a very high degree of strength and excellent toughness. This strength enables considerable reductions to be made in the plate thickness required for steel structures in comparison to conventional steels, thereby contributing to savings in material costs. Furthermore, the high toughness of DILLIMAX steels, combined with very good fabrication properties, also helps to reduce the costs of processing. This is particularly true in the case of welding, where plate thickness reduction directly leads to smaller amounts of weld metal.

DILLIMAX steels are available in a finely graded range of strengths, allowing coverage of the entire spectrum of applications: DILLIMAX 500, 550, 690, 890, 965 and 1100. Our delivery program shows in which dimensions our DILLIMAX steels are normally deliverable. In addition, special dimensions are possible on request.

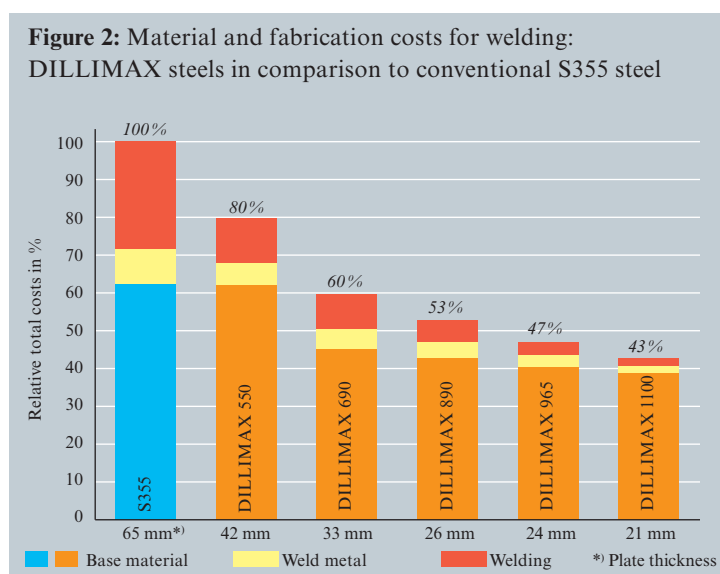


Figure 2 shows how DILLIMAX steels help to minimize material and fabrication costs in comparison to conventional S355 quality steels.

DILLIMAX steels are internationally recognized. The European Standard EN 10025-6 stipulates the requirements on steels which are to be used in highly loaded, welded components (e.g. crane constructions, bridges or flood gates) and also at lower temperatures.

DILLIMAX steels do not just fulfil these requirements, they even exceed them in many cases. DILLIMAX 690 E (S690QL1) is approved by the DIBT (German Institute of Structural Engineering) for the use in steel constructions supervised by the building authorities (general building inspection no. Z-30.1-1). This approval applies to the use in steel constructions in accordance with DIN 18800.

The steel grades DILLIMAX 500 B/T/E (S500Q/QL/QL1), DILLIMAX 550 B/T/E (S550Q/QL/QL1) and DILLIMAX 690 B/T/E (S690Q/QL/QL1) are considered in Eurocode 3, part 1-12 (pr EN 1993-1-12: 2005).



For the following DILLIMAX steel grades, an evaluation of conformity and a CE marking can be carried out according to the European Construction Products Directive: DILLIMAX 500, 550 and 690 B/T/E (up to 150 mm plate thickness), DILLIMAX 890 B/T/E (up to 100 mm plate thickness), DILLIMAX 965 B/T/E (up to 50 mm plate thickness). For the use in the field of supervision by the building authorities, special regulations must be, owing to circumstances, taken into account.

The data shown in this brochure comply in analogy also with EN 10028-6: "Flat products made of steel for pressure purposes – Part 6: Weldable fine grain steels, quenched and tempered."

In the following pages, we would like to introduce to you the special properties of DILLIMAX steels, demonstrate how these properties are produced and how they can be used within the aim of producing highly loaded steel structures while saving costs.



THE MANUFACTURE OF DILLIMAX

The high degree of strength and toughness displayed by DILLIMAX steels is not only achieved by selective alloying, but also by a special manufacturing process: after rolling, the heavy plates are quenched in water and tempered. All processes involved – steel production, shaping into heavy plate and water quenching – are exactly combined for each steel melt.

Melting the Steel

After careful hot metal desulphurization, DILLIMAX steels are produced by melting in a top-blowing basic oxygen process, then treated by ladle metallurgy

and, for usual plate dimensions, cast by continuous casting. For very thick, heavy plates, ingot casting is also available.

A low phosphorus and sulphur content are both prerequisites for high toughness. As a rule, the phosphorus content is below 0.020 % and the sulphur content below 0.005 %. The required alloy content is exactly adjusted in the ladle as well, with a view to an optimum combination of mechanical values and good machinability.

Particular attention is paid to the carbon equivalent (CEV, PCM or CET), which goes up

together with the alloy content. Low carbon equivalent values indicate a good weldability. However, a minimum of alloy elements, which increases with the plate thickness, is necessary to ensure the required mechanical properties after quenching and tempering.

DILLIMAX steels offer though values of carbon equivalent, which are far below the maximal limiting values given in the standard EN 10025-6.

Indicative values of the carbon equivalent of DILLIMAX 690 to 1100 are shown in Table 1.

Table 1: Carbon equivalent of DILLIMAX 690 to 1100 (indicative values)

DILLIMAX	690				890			965		1100
	10	40	100	180	10	40	70	10	40	10
CEV	0.40	0.51	0.63	0.71	0.57	0.60	0.67	0.57	0.60	0.77
PCM	0.24	0.29	0.32	0.34	0.30	0.31	0.33	0.30	0.31	0.32
CET	0.29	0.34	0.38	0.41	0.35	0.36	0.39	0.35	0.36	0.37

Carbon equivalent:

$$CEV = C + Mn/6 + (Cr + Mo + V)/5 + (Cu + Ni)/15$$

$$PCM = C + Si/30 + (Mn + Cu + Cr)/20 + Mo/15 + Ni/60 + V/10 + 5xB$$

$$CET = C + (Mn + Mo)/10 + (Cr + Cu)/20 + Ni/40$$



Shaping into Heavy Plate

DILLINGER HÜTTE GTS has two of the most powerful rolling stands in the world. The slabs produced in the steel works are rolled there according to a rolling schedule precisely defined and tuned to the respective chemical composition of the steel. Thanks to the high rolling forces of up to 108,000 kN (11,000 metric tons), sufficient deformation is achieved in the core of the plate even for large plate thicknesses. The resulting microstructure is thus optimally suited to subsequent quenching and tempering, which is one of the prerequisites for the good

strength and toughness properties of DILLIMAX steels. The reproducibility of the rolling process in terms of rolling temperature, rolling force and thickness reduction ratio is ensured by accurate measurement and fast process control.

Water Quenching

After shaping, the heavy plates are heated up to austenitizing temperature and then cooled down in a special device. The high cooling rate during water quenching leads to a fine-grained, hard microstructure. The subsequent tempering treatment triggers softening and

precipitation processes, which result in a microstructure with high strength and simultaneously good toughness properties. The parameters of the tempering treatment are adjusted to the chemical composition and plate thickness to achieve the required tensile and toughness properties.

Figure 3 shows the fine grained, quenched and tempered microstructure typical of DILLIMAX.

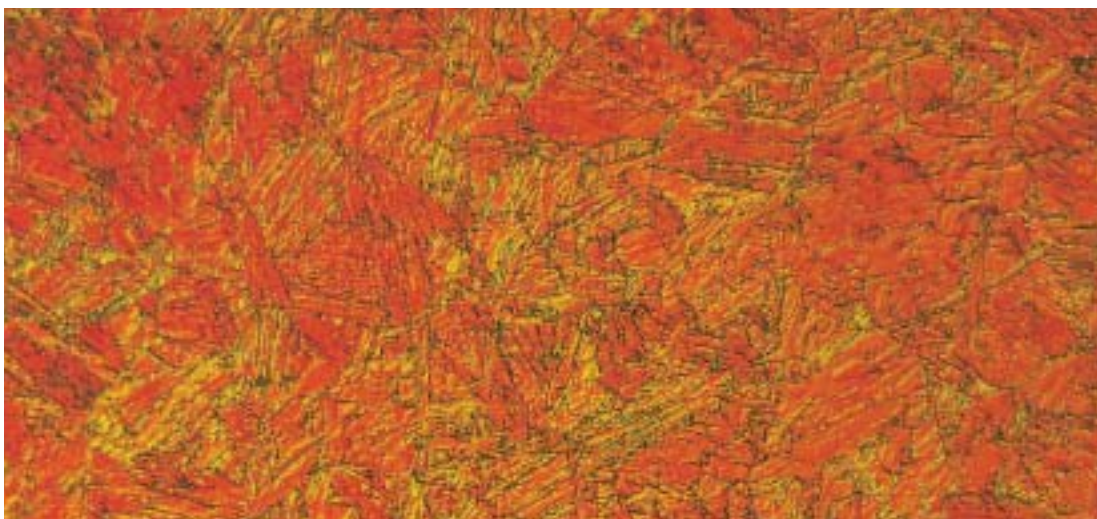


Figure 3: The typical microstructure of DILLIMAX magnified 500 times



THE MATERIAL PROPERTIES OF DILLIMAX

Strength and Toughness

DILLIMAX steels possess strength properties which far exceed those of conventional steels. Table 2 shows the minimum values for yield strength and Table 3 respectively the

tensile strength and minimum elongation values.

In spite of their high degree of strength, DILLIMAX steels possess excellent toughness properties (see Table 4). They are supplied in three toughness

grades: basic grade (B) with minimum notch toughness values at -20 °C, tough grade (T) with minimum notch toughness values at -40 °C, and extra tough grade (E) with minimum notch toughness values at -60 °C.

Table 2: Minimum values for yield strength, depending on plate thickness

Yield point Y.P. in MPa (Y.S. if the yield point is not apparent)								
Thickness (mm)	30	50	60	65	80	100	150	200
DILLIMAX 500	500			480			440	—
DILLIMAX 550	550			530			490	—
DILLIMAX 690		690				670 ¹⁾	630 ¹⁾	610 ¹⁾
DILLIMAX 890	890			850		830	—	—
DILLIMAX 965	960		930		850		—	—
DILLIMAX 1100	1100	—	—	—	—	—	—	—

¹⁾ Higher minimum values can be set on request.



Table 3: Minimum values for tensile strength and elongation, depending on plate thickness

Tensile Strength U.T.S. in MPa							Elongation A ₅ in % ²⁾	
Thickness (mm)	30	50	60	80	100	150	200	all thickness'
DILLIMAX 500	590 – 770				540 – 720		—	17
DILLIMAX 550	640 – 820				590 – 770		—	16
DILLIMAX 690	770 – 940				720 – 900 ¹⁾		700 – 880 ¹⁾	14
DILLIMAX 890	940 – 1100		900 – 1100		880 – 1100		—	12
DILLIMAX 965	980 – 1150		950 – 1120		900 – 1100		—	12
DILLIMAX 1100	1200 – 1500		—		—		—	10

¹⁾ Higher minimum values can be set on request.

²⁾ Minimum elongation.

Table 4: Minimum values for impact energy of DILLIMAX steels (Charpy-V-notch samples)

DILLIMAX 500–965	Specimen direction	Impact energy A _v [J] at a test temperature of			
		0 °C	-20 °C	-40 °C	-60 °C
Basic grade (B)	longitudinal/transverse	40/30	30/27	—	—
Tough grade (T)	longitudinal/transverse	50/35	40/30	30/27	—
Extra tough grade (E)	longitudinal/transverse	60/40	50/35	40/30	30/27

For DILLIMAX 1100, minimum impact energy values of respectively 30 J in longitudinal direction and 27 J in transverse direction at -40 °C are offered.



*Figure 4: O&K hydraulic excavator RH 400: Load bearing structural components made of DILLIMAX 690 T
(Illustration with the kind permission of the Orenstein & Koppel AG, Dortmund, Germany)*



Properties in Through-Thickness Direction

Plates, which are used under a high load in through-thickness direction because of constructive and/or manufacturing reasons, require a high resistance against lamellar tearing.

This must be taken into account for the steel production through the settings of a special production route.

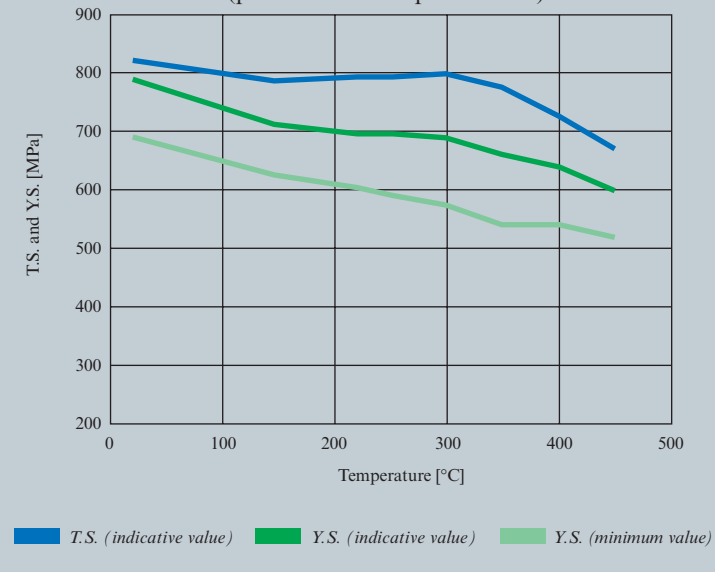
Thus, for example, DILLIMAX 690 can be delivered by agreement in a large thickness range under fulfilment of the quality class Z35 in accordance with EN 10164.

High-Temperature Strength

The selective use of alloying elements and particular quenching and tempering treatment confers DILLIMAX 690 steels

and above good high-temperature strength up to 500 °C (see Figure 5). Minimum values for high-temperature strength can be guaranteed on request.

Figure 5: Effect of temperature on the strength properties of DILLIMAX 690 (plate thickness up to 50 mm)





THE PROCESSING OF DILLIMAX

It must generally be taken into account, that the processing requires more care as the minimum yield strength values of the steels and/or the plate thickness increase, in order to rule out an inadmissible deterioration of the mechanical properties. It also must be considered, that the chemical composition of DILLIMAX steels varies depending on the plate thickness, from which certain differences in the processing may result.

A construction suitable to the application is a fundamental condition for a successful use of high strength, fine-grained structural steels. On the basis of relevant standards, the user should ensure that his design, construction and processing methods are aligned with the material, correspond to the state-of-the-art that the fabricator has to comply with and are suitable for the intended application.

In this brochure some fundamental advice for the processing

of DILLIMAX steels is given. Of course, not all the possibilities and boundary conditions of the processing can be commented. Please contact DILLINGER HÜTTE GTS for your special questions.

Cold forming

Cold forming of DILLIMAX steels can easily be carried out by bending. It must be noted that the force needed to form a given plate thickness increases with the yield strength of the steel. The elastic spring back effect also becomes more significant.

In order to prevent the danger of cracks arising from the sheared or flame cut edges, these must be ground in the areas where cold forming is intended. Shearing burs shall be removed and edges rounded. Deep drag lines and gougings shall be ground flush in order to prevent stress and strain concentrations during cold forming. For high strength steels, notches

(e.g. hard stamps) on the plate surface increase the risk of a crack formation and shall be removed in the forming area.

The elongation of steel decreases as its yield strength increases. This law must be taken into account for cold forming as well by adapting the maximum plastic elongation applied to the yield strength class. The plastic elongation on the plate surface, which occurs during bending, arises from the bending radius (r) and the plate thickness (t), following the rule:
Elongation (%) = $100 / (1 + 2 r/t)$.

Assuming a certain maximum deformation rate (less than 10 % elongation per second in the outer fibre), certain minimum bending radii and die openings can be used as reference values for DILLIMAX (see Table 5).



Figure 6: Pipes made of DILLIMAX 690 for the penstock linings of the hydropower plant Kárahnjúkar
(Illustration used with the kind permission of DSD Noell GmbH, Würzburg, Germany)



Cold forming causes a hardening of the steel which is accompanied by a decrease in toughness. This can be demonstrated by the impact test where deformation causes an increase in the transition temperature $T_{27 J}$,

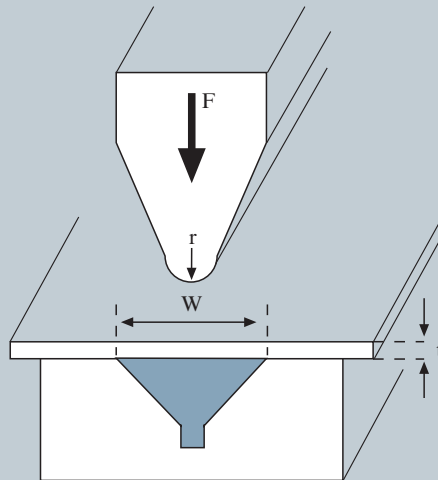
at which the absorbed energy value fall below 27 J (shift of the curve to higher temperatures). This transition temperature shift is practically the same for both quenched and normalized steels, the average being, as

experience has shown, $5^{\circ} C$ for each percent of cold forming. Thus DILLIMAX steels still show, as a rule, very good values of toughness.

Table 5: Minimum bending radii and die openings for DILLIMAX steels for cold forming

DILLIMAX	500		550		690		890 , 965		1100	
	perp.	parallel	perp.	parallel	perp.	parallel	perp.	parallel	perp.	parallel
Position of bending line to rolling direction										
Bending radius	1t	1.5t	1.5t	2.5t	2t	3t	3t	4t	5t	6t
Die opening	6t	7t	6t	7t	7t	9t	9t	12t	14t	16t

t = plate thickness, forming time > 2 s for 90° bending angle





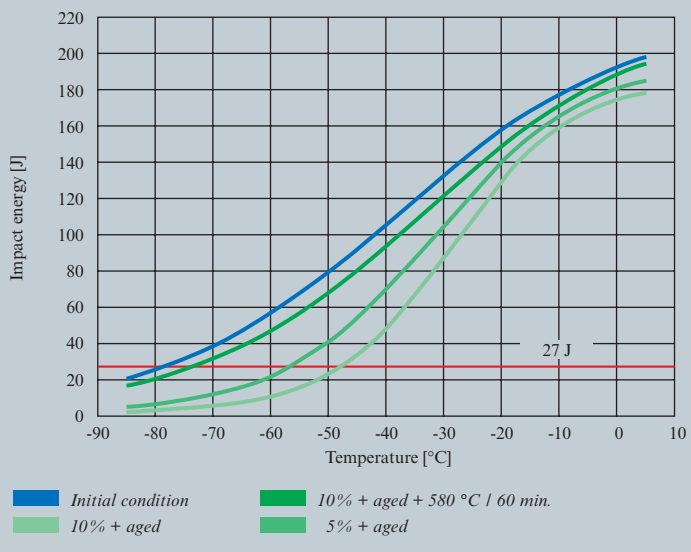
An additional decrease in toughness must be taken into account, due to so-called ageing, an embrittlement phenomenon which cold-formed steels are subject to over a period of time.

Whereas this process can take years at room temperature, it takes only a few minutes at about 200 °C. Ageing can also be accelerated when welding is carried out in the cold-formed areas. The reserves of toughness shown in the initial state, the degree of cold forming and the lowest application temperature of the component are, therefore, the decisive criteria for the resistance of a cold-formed steel to brittle fracture.

As Figure 7 shows on the basis of Charpy impact transition curves, DILLIMAX steels are

not susceptible to above-average decrease in toughness as a result of cold forming and ageing.

Figure 7: Effect of cold forming, ageing and stress relieving on the Charpy impact transition curves of DILLIMAX 690 T grade (plate thickness 30 mm)





Annealing in the stress relieving temperature range (see section “Stress relieving”, p. 33) carried out after forming reduces ageing-induced embrittlement.

Depending on the application for which the DILLIMAX steels are intended, various fabrication codes apply, which lay down the maximum permissible scope of cold forming and stipulate the corresponding heat treatment. Also welding in strong cold formed areas (e. g. > 5%) is forbidden in some fabrication codes. If the welded component is to be stress relieved, separate annealing after cold forming can be dispensed with.

Hot Forming

In the case of narrow bending radii and large wall thicknesses, it may be advantageous to carry out forming at higher temperatures, since the required forming forces are lower. This method, however, has a serious disadvantage: hot forming takes place, as a rule, above the maximum permissible temperature for stress

relieving. In this temperature range, DILLIMAX steels inevitably lose their original mechanical properties resulting from the water quenching.

Consequently, hot forming DILLIMAX steels is not permissible if no renewed quenching and tempering is subsequently to be carried out.

Even with renewed quenching and tempering, it should be noted that the mechanical properties of DILLIMAX steels may deteriorate. DILLINGER HÜTTE GTS cannot guarantee satisfactory results with renewed quenching and tempering. Firstly, the efficiency of the heat treatment equipment which manufacturers have at their disposal varies a great deal, and secondly, satisfactory quenching and tempering results are more difficult to achieve due to the component geometry which, in comparison to unprocessed plate, is more complicated. Consequently, the chemical composition of the steel must be adjusted accordingly beforehand in

consultation with DILLINGER HÜTTE GTS for components which are to be quenched and tempered during fabrication.

As far as is possible, austenitizing of DILLIMAX steels should take place at temperatures between 900 °C and 950 °C if renewed quenching and tempering is intended. During subsequent hardening in water, a high rate of heat dissipation should be ensured in order to secure sufficient hardening of the component. The subsequent tempering process depends on the chemical composition, dimensions and required mechanical properties and should likewise be determined in consultation with DILLINGER HÜTTE GTS.



Forming within the Stress Relieving Temperature Range

According to definition, this process belongs to the cold forming category. However, in this range of temperature, the yield strength is already significantly lower than at room temperature, and the forming forces required thus decrease proportionally, without any decisive change, however, in the initial heat treatment microstructure. In addition, toughness is less impaired than when cold forming at room temperature.

Subsequent renewed quenching and tempering can be dispensed with if forming temperatures are approximately 50 °C to 80 °C below the tempering temperature and the amount of working is under 2 %.

When higher amounts of working are involved, it should be determined whether the mechanical values of the steel (toughness, elongation) are still reached after forming.

The forming of DILLIMAX 1100 within the stress relieving temperature range is not permissible.

Thermal Cutting

Flame cutting, plasma arc cutting or laser cutting of DILLIMAX steels is possible without difficulty, if carried out properly and using appropriate tools in good working condition.

Since different manufacturers have developed a variety of tools, you should note the respective settings and advice prescribed by the manufacturers in the cutting tables (nozzle selection, gas pressure, working methods, speed etc.).

The surface condition of the plate also has a pronounced influence on the flame cutting conditions and the cut face quality that can be achieved. Where high demands are placed on the cut face quality, it is necessary to clean the top and bottom of the workpiece around the cut from scale, rust, paint and any other impurities.

Generally, it is not necessary to preheat Dillimax 500 prior to flame and arc cutting if the temperature of the workpiece is 15 °C or above. However, for the high strength DILLIMAX steels, if the cutting edges are to undergo cold forming in the course of further processing, e.g. through bending, a zone approximately 100 mm wide within the forming area has to be preheated to a temperature between 120 °C and 200 °C. Alternatively, the hardened areas resulting from flame cutting must be ground away in the forming area.

Figure 8 shows typical hardness curves of a DILLIMAX 690 grade in the heat-affected zone (HAZ) of the flame cutting edge.

For DILLIMAX 550 to 1100, we recommend adherence to certain minimum preheating temperatures for flame cutting (see Table 6).



Figure 8: Typical hardening of DILLIMAX 690 at the flame cutting edge after oxycutting (plate thickness: 20-30 mm)

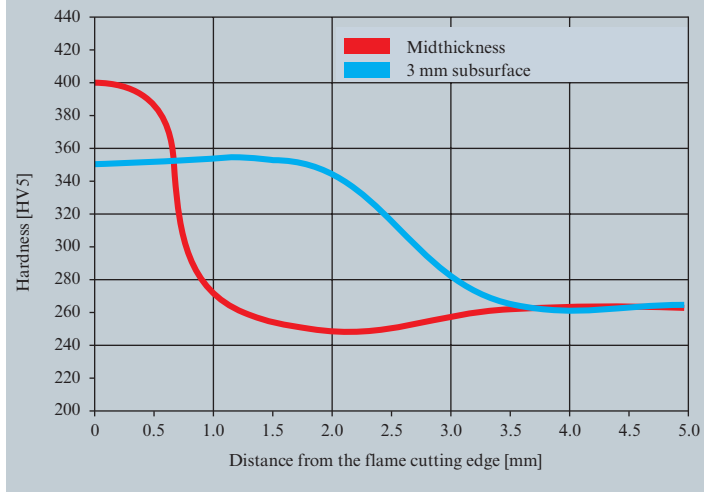


Table 6: Minimum preheating temperatures for flame cutting of DILLIMAX 550 to 1100

Plate thickness [mm]	< 20	< 50	< 100	> 100
DILLIMAX 550	25 °C	25 °C	50 °C	100 °C
DILLIMAX 690	25 °C	50 °C	100 °C	150 °C
DILLIMAX 890	50 °C	100 °C	150 °C	—
DILLIMAX 965	50 °C	100 °C	—	—
DILLIMAX 1100	75 °C	125 °C ¹⁾	—	—

¹⁾ DILLIMAX 1100 is only available up to 30 mm plate thickness as a standard

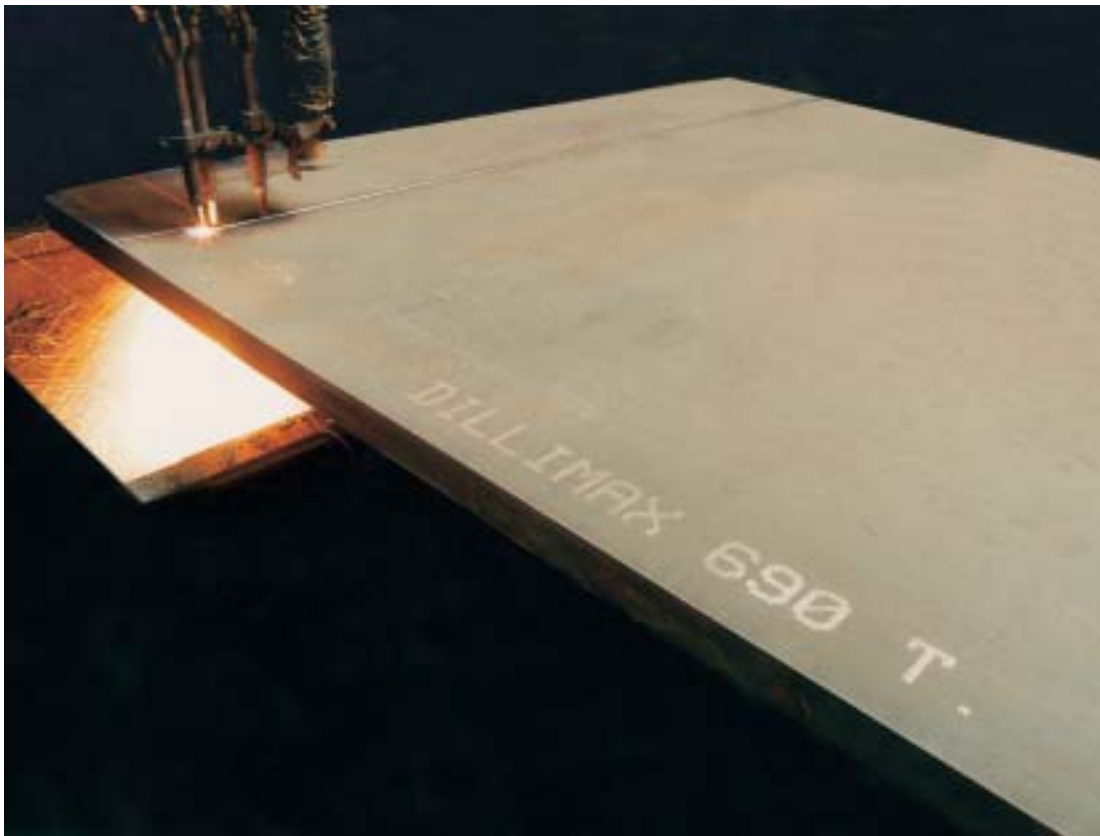


Figure 9: Oxyacetylene cutting of DILLIMAX 690 T



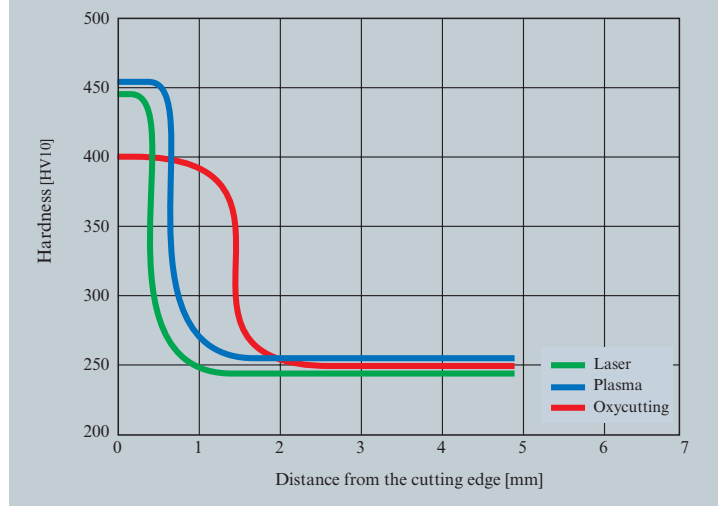
Laser and plasma cutting:

The major advantages of laser and plasma cutting lie in the higher cutting performance and the narrower heat-affected zone, along with minimum heat input. With both cutting processes, it is possible to cut even the smallest parts, lamellae and screen plates without distortion. With these methods, it is also possible to dispense with preheating.

A perfect surface of the plate is a fundamental precondition for successful laser cutting, because the laser beam must be concentrated without reflection loss and absorbed without disturbance on the so-called focus on the surface of the plate.

If required, all DILLIMAX steels can be supplied shot-blasted and coated especially for this purpose. The achievable cutting performance depends to a great extent on the laser power and the plate thickness to be cut. With a plate thickness of 10 mm and a laser energy of

Figure 10: Typical effect of various flame cutting processes on the heat-affected zone of a water quenched, fine-grained structural steel with a yield strength of 690 MPa



2-3 kW, cutting speeds of up to 2000 mm/min are possible. With suitable surface treatment, e.g. the use of an emulsion, it may even be possible to improve this performance.

Unlike laser cutting, plasma cutting is also suitable for plate thicknesses of more than

30 mm. However, the heat-affected zone is somewhat wider. Figure 10 shows the typical effect of the different cutting methods on the heat-affected zone of a quenched, high strength, fine-grained structural steel.



Welding

Weldability: DILLIMAX steels are suitable for welding if the general welding regulations (EN 1011, see section “Literature”, p. 44) and the following advice are observed. Submerged arc welding can be carried out for grades up to DILLIMAX 690, manual arc welding for grades up to DILLIMAX 890, and gas shielded arc welding for grades up to DILLIMAX 1100.

As the yield strength increases, particular care should be taken during processing, especially in the case of heat input during welding.

DILLINGER HÜTTE GTS points out that the following recommendations for welding are purely for information. The wide variety of welding conditions, the construction and the consumables used have a signifi-

cant effect on the quality of the welded joints. Since the respective operating and processing conditions are not known, it is not possible to guarantee in advance the mechanical properties of the weld or the lack of defects in the weld. However, DILLINGER HÜTTE GTS predicts good results, if suitable conditions for welding are provided.

Preparation of the weld seam:

The weld seam can be prepared by machining or by thermal cutting. At the beginning of the welding process, the seam must be bright, dry and free from flame cutting slag, rust, scale, paint and any other impurities.

Filler metals and consumables:

The filler metals must be selected according to the required mechanical properties. Since the weld metal may mix with the base material, root welds can be created with fillers which pro-

duce a “softer” weld metal than the associated filler and cap passes. The same applies to fillet welds which are not subjected to full load – in this case, too, it is often possible to use “softer” fillers by increasing the weld thickness. Basic-coated rod electrodes are principally used in manual arc welding for reasons of toughness. Basic-coated rod electrodes possesses two outstanding properties: the impact energy of the weld metal is higher, especially at low temperatures, and the amount of hydrogen introduced is lower than with any other type of coating.

Drying and storage must be carried out according to the manufacturer’s instructions. With the same considerations in mind, only basic powders should be used for submerged arc welding.

A summary of suitable weld fillers is shown in Table 7.



Table 7: Filler metals and consumables for welding of DILLIMAX steels

DILLIMAX	Manual arc welding (SMAW)	Submerged arc welding (SAW)	Gas shielded metal arc welding (GSAW)	Manufacturer
500	FOX EV63	3NiMo1-UP/BB24	NiMo1-IG Union TG 55 Ni	Böhler Th. Schweiß.
	—	Topcore 740B/ST55,ST65 Topcore 741B/ST55,ST65	Megafil 740B, 741B, 821B /M21, CO2	Drahtzug Stein
	OK 74.78	OK13.39/ OK Flux 10.61	OK Tubrod 15.06	ESAB
	Tenacito 70	OE-S3NiMo1-OP121TT Fluxocord 41-OP121TT	Carbofil NiMo1 Fluxofil 41	Oerlikon
	Phoenix SH schwarz K	Union S4Mo/UV421TT Union S2 NiMo1/UV421TT	Union K5 Ni	Thyssen Schweiß.
550	FOX EV65/70/70Mo	3NiMo1-UP/BB24		Böhler Th. Schweiß.
	—	Topcore 741B/ST55,ST65	Megafil 940M / M21 Megafil 741 / M21, CO2	Drahtzug Stein
	Tenacito 65R	OE-S3NiMo1-OP121TT Fluxocord 41-OP121TT	Carbofil NiMo1 Fluxofil 41	Oerlikon
	Phoenix SH Ni2 K90	Union S3 NiMo/UV421TT Union S3 NiMo1/UV421TT	Union MoNi	Thyssen Schweiß.
690	FOX EV 85	3NiCrMo2.5-UP/BB24	NiCrMo2.5-IG, X70-IG, NiMoCr-IG Union MV NiMoCr	Böhler Th. Schweiß.
	—	Topcore 742B/ST55	Megafil 742M / M21	Drahtzug Stein
	OK 75.75, OK 75.78	OK Autrod13.44/OK Flux10.62	OK Autrod 13.31	ESAB
	Tenacito 75 Tenacito 80	OE-SD3 2,5NiCrMo/OP121TTW Fluxocord 42/OP121TTW	Carbofil NiMoCr Fluxofil 42 / M42	Oerlikon
	Phoenix SH Ni2 100	UnionS3NiMoCr/UV421TT	Union NiMoCr Union X90	Thyssen Schweiß.
890	FOX EV 100	—	X90-IG	Böhler Schweiß.
	—	Topcore 745B/ST55	Megafil 1100M / M21	Drahtzug Stein
	OK 75.78	—	OK Autrod 13.31	ESAB
	Tenacito 100	—	Fluxofil 45	Oerlikon
	Phoenix SH Ni2 130	—	Union X90 Union X96	Thyssen Schweiß.
965	—	—	Megafil 1100M / M21	Drahtzug Stein
	Tenacito 140 = Tenax140	—		Oerlikon
	—	—	Union X96	Thyssen Schweiß.



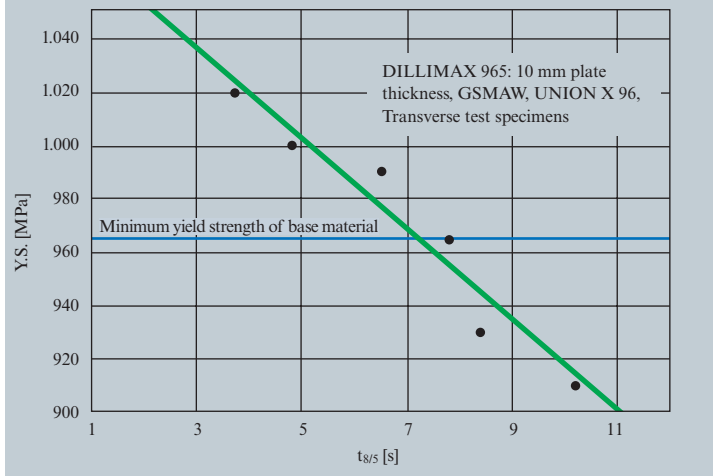
Heat input per unit length of weld and heat cycles during welding:

The cooling time or so-called $t_{8/5}$ time in which the temperature of a bead drops from 800 °C to 500 °C is generally used to describe the heat cycles occurring during welding. This cooling time is primarily determined by the heat input per unit length of weld, the preheating or interpass temperature and, particularly for thin plates, by the plate thickness and the weld seam configuration.

The $t_{8/5}$ time has to be calculated according to the standard EN 1011.

In order to make sure that the properties of the steel are not excessively impaired by the thermal load during welding, it is necessary to set upper limits for the cooling time, and therefore, for the heat input per unit length of weld. Figure 11 shows how what effect an in-

Figure 11: Effects of the $t_{8/5}$ time on the yield strength of the weld metal of DILLIMAX 965



creasing $t_{8/5}$ time has on the yield strength (Y.S.) of the weld metal.

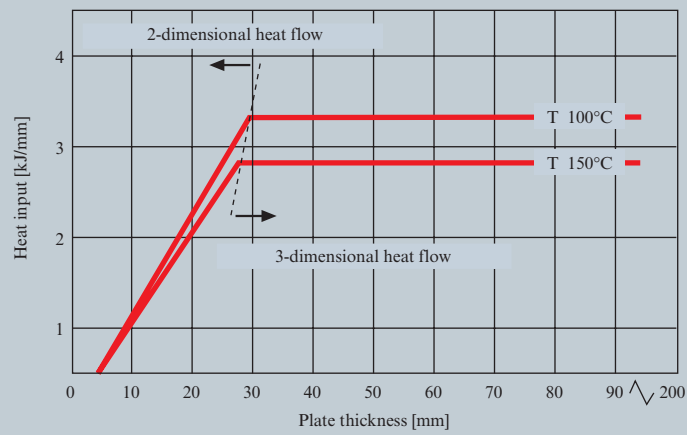
Furthermore, a lower limit for the $t_{8/5}$ time is also necessary: Excessive hardening of the heat-affected zone can be caused by cooling down too rapidly. Moreover, hydrogen effusion, which

promotes hydrogen-induced cracking in the weld metal and heat-affected zone, is prevented (see section “Prevention of Cold Cracking” p. 28). Figures 12 to 14 give advice on the selection of suitable $t_{8/5}$ times and the maximum permissible heat input when welding DILLIMAX 690 to 1100.

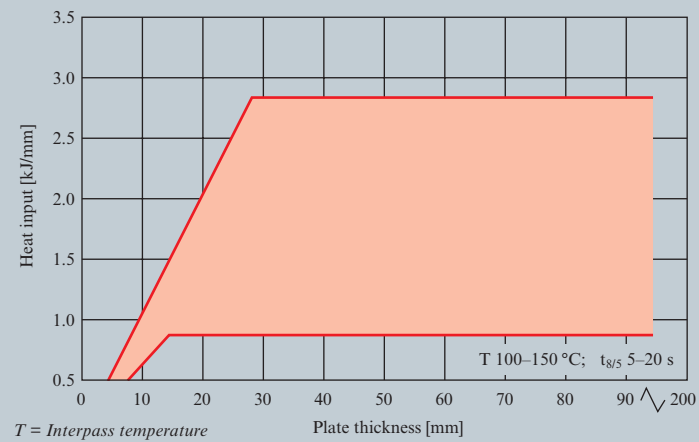


Figure 12: DILLIMAX 690: Heat input during welding in relation to plate thickness

(a) Maximum permissible heat input for $t_{8/5} < 20$ s



(b) Recommended work range

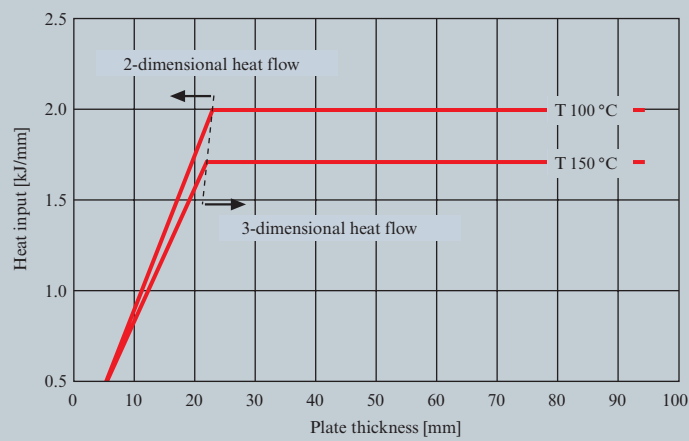


T = Interpass temperature



Figure 13: DILLIMAX 890: Heat input during welding in relation to plate thickness

(a) Maximum permissible heat input for $t_{8/5} < 12$ s



(b) Recommended work range

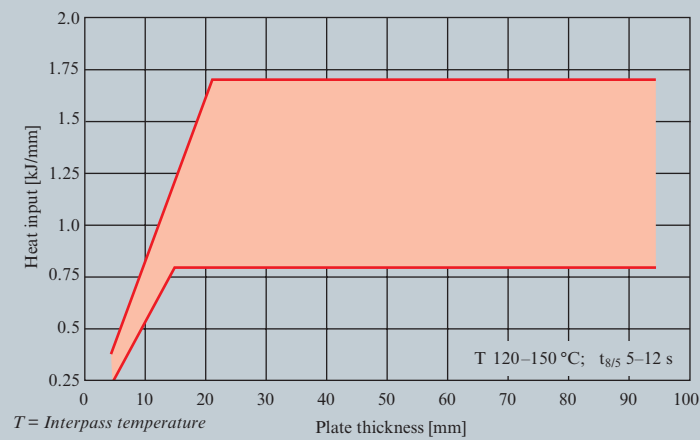
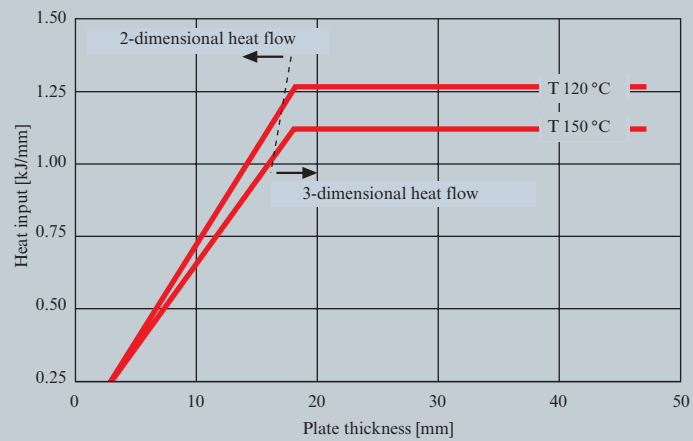


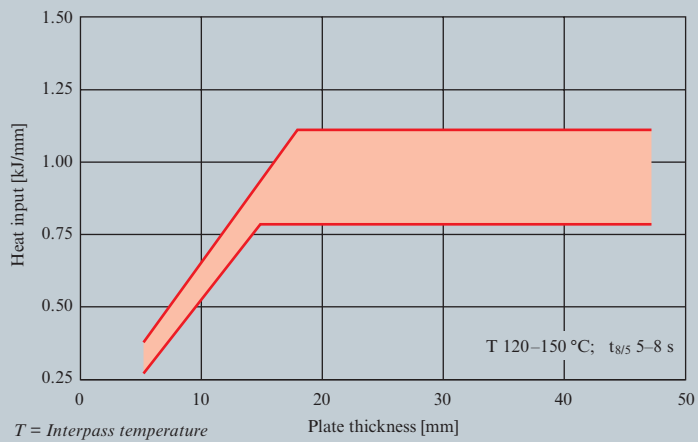


Figure 14: DILLIMAX 965/1100: Heat input during welding in relation to plate thickness

(a) Maximum permissible heat input for $t_{8/5} < 8$ s



(b) Recommended work range



T = Interpass temperature

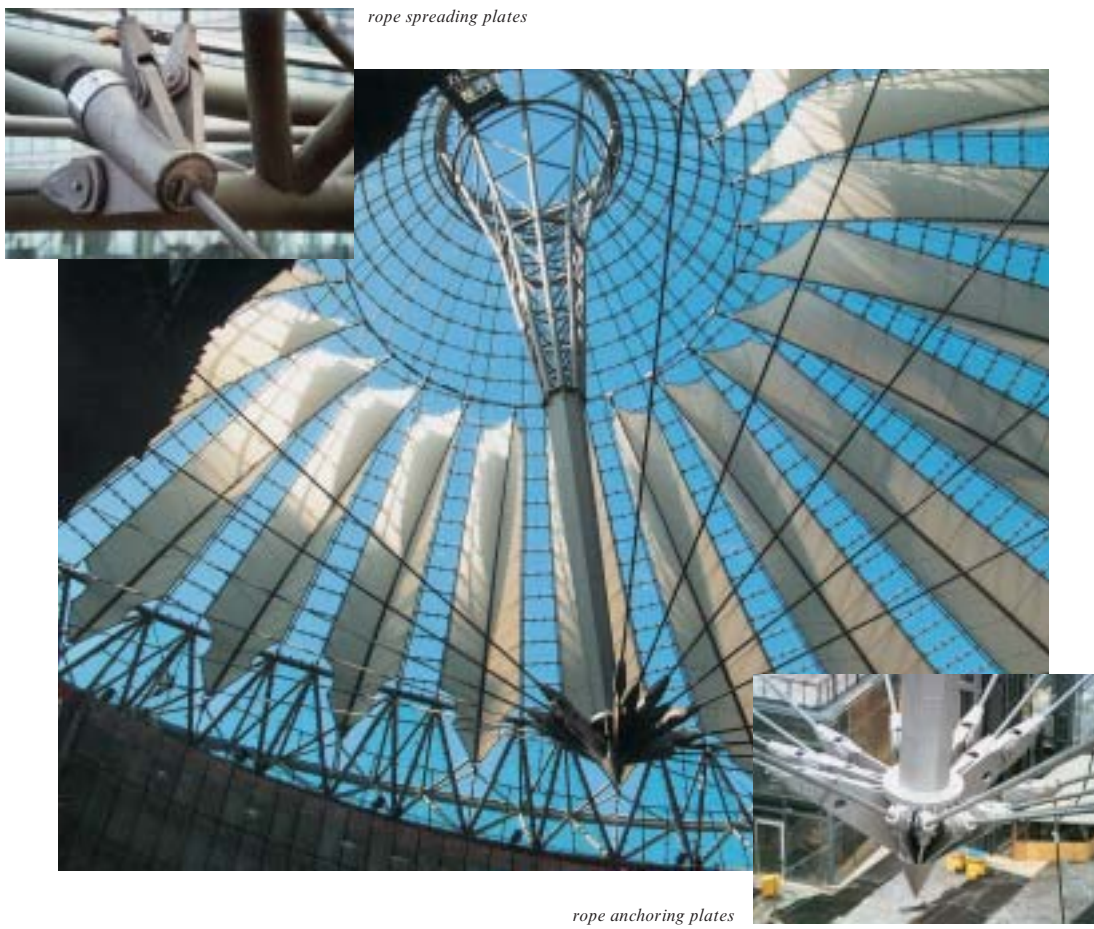


Figure 15: Roof structure of the Sony-Center in Berlin, with DILLIMAX 690 straps for carrying beams, rope spreading and rope anchoring plates
(Illustration used with the kind permission of Waagner-Biró AG, Wien, Austria)

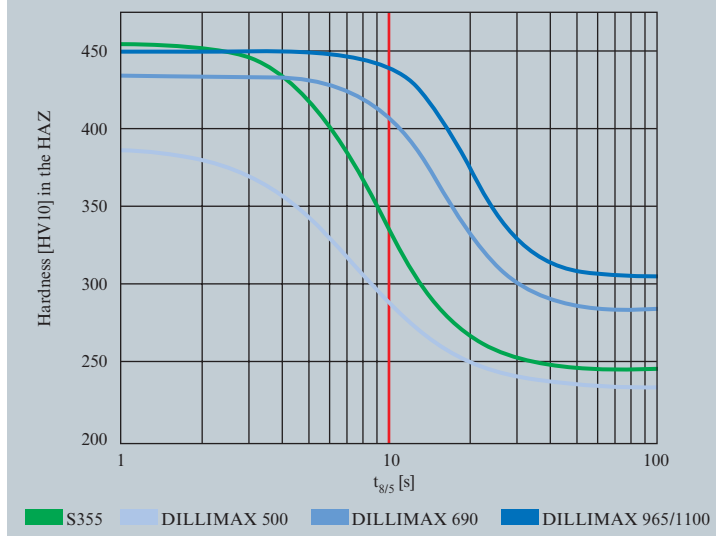


Prevention of cold cracking:

As with all high strength, quenched and tempered fine grained structural steels, DILLIMAX steels are susceptible to cracking in the weld area if the conditions are unfavourable. The hazard is that these cracks may not appear until 48 hours after welding. This must be taken into account when inspecting for cracks.

In principle, cold cracking can though be prevented, if appropriate precautionary measures are taken during welding and, above all, two of the factors which promote cold cracking are eliminated: hydrogen in the weld metal and residual stresses. A third influential factor, hardening in the heat-affected zone of DILLIMAX steels, can only be partially controlled due to

Figure 16: Hardening in the heat-affected zone of various DILLIMAX steels in comparison to conventional S355 steel after cooling with different $t_{8/5}$ times



the increased alloy content of base material and fillers. Figure 16 shows typical values

for hardening of the heat affected zone in DILLIMAX steels with various $t_{8/5}$ times.



Deposits of molecular hydrogen at the grain boundaries of the weld metal structure and on the fusion line are the main causes of cracking. The hydrogen enters the weld through moist weld fillers, films of moisture on the weld edges or the atmosphere surrounding the arc. It can be avoided by selecting suitable weld fillers, keeping them dry in storage and above all by preheating the component to be welded.

Preheating leads to a delay in the cooling of the component after welding, which means that the hydrogen has enough time to diffuse out. This phenomenon mainly takes place in the temperature range between 300 °C and 100 °C.

Preheating not only refers to the heating of the weld area at

the beginning of the welding process, it also means adherence to a certain minimum temperature throughout the whole welding process (interpass temperature). The preheated area should extend to at least 100 mm on either side of the seam.

Recommended preheating temperatures for DILLIMAX 690 to 1100 are given in Figures 17 to 19.

For plate thickness above 30 mm, as well as welding techniques which introduce a large amount of hydrogen into the workpiece (e.g. submerged-arc welding), it is advisable to carry out low-hydrogen annealing at 200 °C immediately after welding. The annealing time depends on the thickness of the component and should not be shorter than two hours.

The risk of cracking occurring in welded joints as a result of residual stresses is particularly great for an only partially filled seam cross-section. Therefore, cooling down below the prescribed interpass temperature must be avoided during the entire welding process. To keep residual stress as low as possible, harsh cross-sectional transitions and concentration of welds must be avoided.

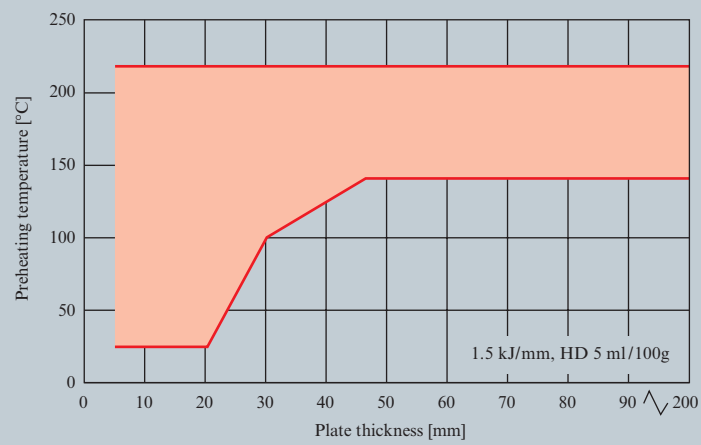
Make sure as well that the components to be welded form a good fit and that the welds are free from notches as far as possible. An advantageous weld sequence can also reduce the level of residual stresses.

Basically, the weld sequence should be selected to ensure that the individual components can shrink freely for as long as possible.



Figure 17: DILLIMAX 690: Recommended preheating temperatures in relation to plate thickness

(a) Manual arc welding



(b) Gas shielded metal arc welding

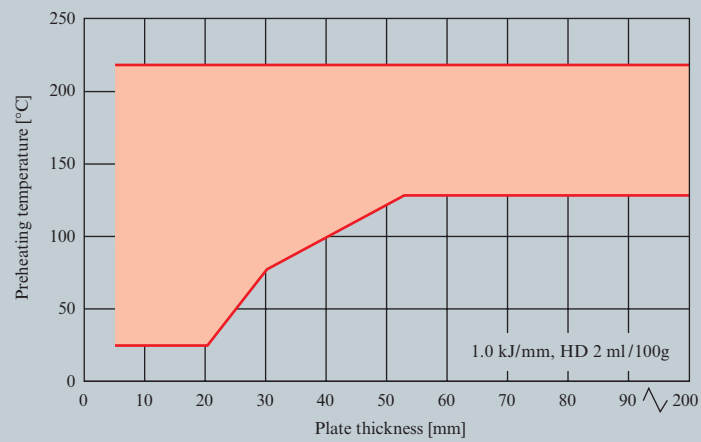
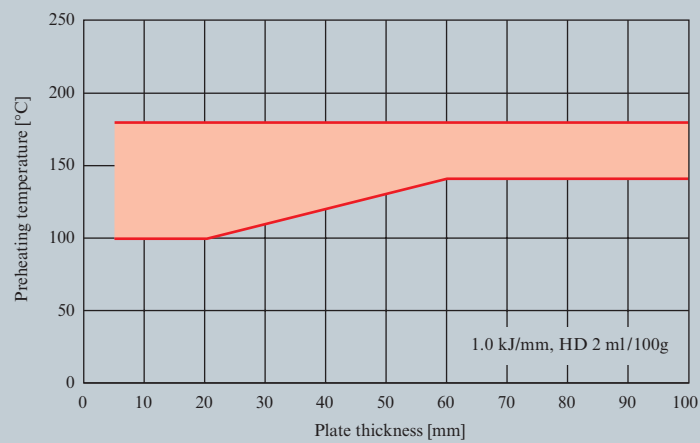




Figure 18: DILLIMAX 890: Recommended preheating temperatures in relation to plate thickness

(a) Gas shielded metal arc welding/butt weld



(b) Gas shielded metal arc welding/fillet weld

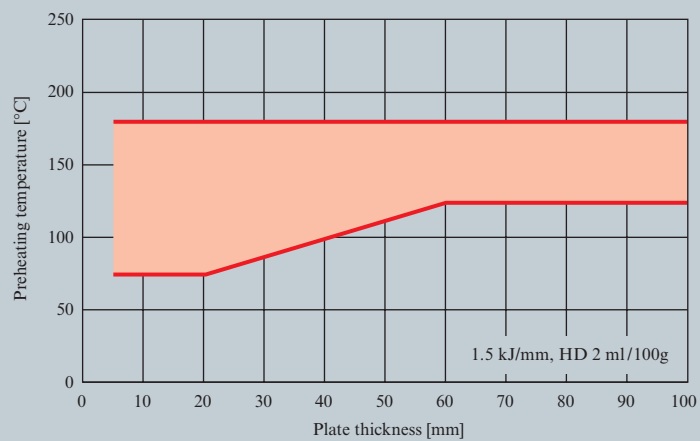
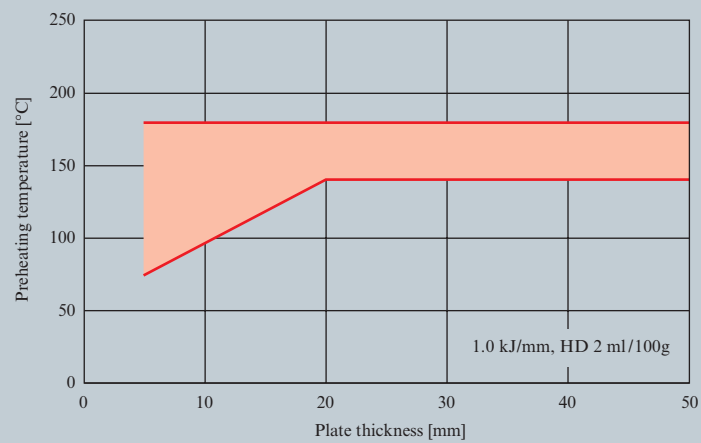


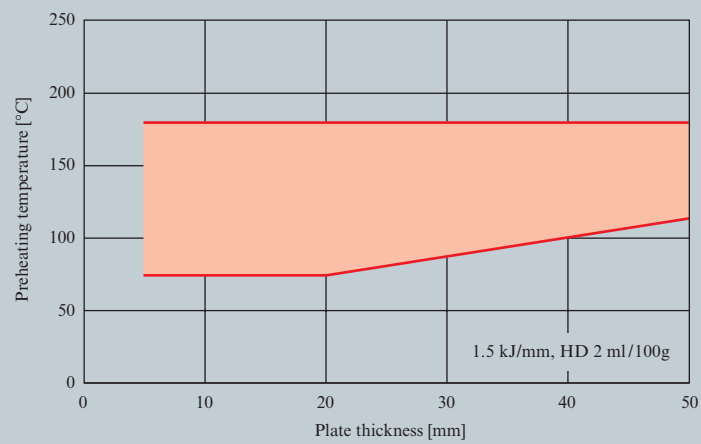


Figure 19: DILLIMAX 965/1100: Recommended preheating temperatures in relation to plate thickness

(a) Gas shielded metal arc welding/butt weld



(b) Gas shielded metal arc welding/fillet weld





Stress Relieving

DILLIMAX steels and their appropriately welded joints have a degree of toughness sufficient for them to be used in highly loaded components, in general without necessity of a stress relieving treatment.

If stress relieving is necessary due to regulations or for constructive reasons, the plate manufacturer should be consulted.

In general, the highest stress relieving temperature should be 40 °C below the tempering temperature of the quenching process. If such a heat treatment is to be carried out by the fabricator, it must be specified when ordering that the respective tempering temperature at DILLINGER HÜTTE GTS has to appear on the works certificate. The holding time when annealing should not exceed 60 minutes. If longer holding times are prescribed, the stress relieving temperature is to be further reduced in relation to the tempering temperature. In case of high level of residual stresses or for very thick plates, care must be taken to avoid pronounced differences in temperature in the component while

heating up to annealing temperature. In case the stress relieving temperature is laid down, i.e. the customer cannot take into account the tempering temperature during plate manufacturing, DILLINGER HÜTTE GTS should be consulted as early as the inquiry stage.

Due to their chemical composition and heat treatment, DILLIMAX steels have a relatively high strength at elevated temperatures. Their stress relief during stress relieving is thus less complete than for ordinary structural steels.

Stress relieving of DILLIMAX 1100 is not permissible.

Flame Straightening

Flame straightening of plates in the steel construction sector is a technique often used to form complex components and achieve even cross-sections. DILLIMAX steels up to DILLIMAX 965 can be flame-straightened without any problems. However, certain general conditions must be adhered to, as is the case with the processing of conventional steels. A distinction is to be made between flame straightening with line heating and flame

straightening with heat spots and triangular shaped temperature fields.

Flame straightening of DILLIMAX 1100 is not permissible.

Flame straightening with line heating: Operational tests have shown that no reduction in the strength properties or impact properties occurs with linear flame straightening of DILLIMAX 690 up to 800 °C.

For DILLIMAX grades with higher yield point, a drop of the tensile and toughness properties is to be expected in case of high heat input.

Flame straightening with heat spots and triangular temperature fields: In comparison to flame straightening with line heating, this method heats the entire plate cross-section, thus resulting in detrimental longer holding times at peak temperature (above the tempering temperature) and longer cooling times. The flame straightening temperature should not exceed 650 °C for any of the DILLIMAX steels up to DILLIMAX 890 (for DILLIMAX 965: 600 °C).



Galvanizing

During pickling or galvanizing high strength steels may have a tendency to crack formation. The risk of cracks during hot galvanizing depends not only on the material selection, but also on the construction, the internal stresses, the composition of the zinc bath and the process control during the galvanizing. For this reason the use of higher strength, quenched and tempered steels in hot galvanized constructions has to be handled with a particular care. In any case the steel manufacturer and the galvanizing plant must be consulted.

Machining

Despite their high degree of strength, DILLIMAX steels are easy to machine. However, some basic rules have to be observed when machining these high strength steels. Vibrations should be avoided. It is therefore advisable to work on a machine that is as rigid as possible, and to keep the gap between the workpiece and the machine (support) to a minimum. Similarly, it is advisable to fix the workpiece firmly to the workbench.

Depending on the type of machining work, sufficient cooling should be ensured. An interruption of the coolant supply or insufficient coolants and lubri-

cants may lead to overheating of the cutting edge, which may cause increased tool wear, and in extreme cases lead to its breakage. Please note the relevant information given by the tool manufacturer.

The recommendations given in the following tables for the selection of tools and the machining of DILLIMAX steels are guidelines which may lead to different results for different machines. The validity of these recommendations should be checked by the processing specialist on site. Detailed information about machining and tool selection can be obtained by consulting tool manufacturers or DILLINGER HÜTTE GTS.



Drilling: DILLIMAX steels are easy to drill. Suitable tools are cobalt-alloyed HSS twist drills, twist drills with brazed carbide cutting tips, solid carbide twist drills (with internal coolant where appropriate), and drills with indexable inserts. The use

of short drills is recommended. For stable drills, the feed rate should be set rather higher when machining begins to ensure that the tool engages firmly. This helps reduce vibrations. Before the drill is completely through the material, feed should be in-

terrupted briefly. This reduces the tension on both machine and tool and avoids breaking of the cutting edges. Details on the selection of tools, cutting speeds and feed rate can be found in Table 8.

Table 8: Recommendations for drilling DILLIMAX 690 to 1100

DILLIMAX	Tool type (Cutting material)	Cutting speed V_c [m/min]	Feed f [mm/rev.] depending on diameter		
			5 – 15 mm	20 – 30 mm	30 – 40 mm
690	Cobalt-alloyed HSS twist drill ¹⁾ (TIN, TiCN) ²⁾	10 – 15	0.05 – 0.15	0.15 – 0.25	0.20 – 0.25
	Drill with indexable inserts ¹⁾	80 – 100	–	0.10 – 0.12	0.12
890	Twist drill with brazed carbide cutting or solid carbide twist drill ²⁾	35 – 50	0.05 – 0.15	0.15 – 0.25	0.20 – 0.25
	Cobalt-alloyed HSS twist drill ¹⁾	8 – 12	0.05 – 0.16	0.20 – 0.25	–
	Drill with indexable inserts ¹⁾	70 – 90	–	0.10 – 0.12	0.12
965	Solide carbide – heavy duty drill (TIN) ²⁾	35 – 50 without internal cooling 40 – 70 with internal cooling	0.10 – 0.20	0.15 – 0.25	–
	Cobalt-alloyed HSS twist drill ¹⁾	8 – 10	0.05 – 0.16	0.16 – 0.25	–
	Drill with indexable inserts ¹⁾	60 – 80	–	0.10 – 0.12	0.12
1100	Solide carbide – heavy duty drill (TIN) ²⁾	35 – 50 without internal cooling 40 – 70 with internal cooling	0.10 – 0.20	0.18 – 0.25	–
	Cobalt-alloyed HSS twist drill ¹⁾	6 – 10	0.05 – 0.16	0.18 – 0.25	–
	Drill with indexable inserts ¹⁾	50 – 70	–	0.10	0.10

¹⁾ Results obtained with tools manufactured by Ferrotec, Bielefeld, Germany

²⁾ Results obtained with tools manufactured by Fette GmbH, Schwarzenbek, Germany

Cooling agent or lubricant: emulsion



Countersinking: Cylindrical and conical countersinking in high strength DILLIMAX plates can best be performed if the tool has a pilot, as this helps avoid vibrations. The use of three-edged countersinkers can also help reduce vibrations. Recommendations for cutting speed and feed rate are given in Table 9.

Tapping: Screw-threads can generally be cut by machine. Details on the selection of tools, cutting speeds and machine speeds are given in Table 10.

Sawing: When using a band saw to saw high strength DILLIMAX steels, we recommend grinding the flame cutting edge 1-2 mm deep in the area to be sawn and sawing the smallest cross-section. Cobalt-alloyed or carbide-tipped saw blades have proved themselves here. Attention should be paid to good cooling.

Table 9: Recommendations for countersinking DILLIMAX 690 to 1100

DILLIMAX	Tool type (Cutting material)	(Cutting speed) V_c [m/min]	Feed f [mm/rev.] depending on diameter	
			15 – 30 mm	30 – 60 mm
690 890 965 1100	Countersinkers made of solid carbide or with indexable inserts ¹⁾	30 – 40	0.10 – 0.20	0.15 – 0.25

¹⁾ Results with tools manufactured by Fette GmbH, Schwarzenbek, Germany and Ferrotec, Bielefeld, Germany

Cooling agent or lubricant: emulsion

Table 10: Recommendations for tapping DILLIMAX 690 to 1100

DILLIMAX	Tool type (Cutting material)	(Cutting speed) V_c [m/min]	Speed n [rpm] depending on thread diameter				
			M10	M16	M20	M30	M42
690 890 965 1100	Manual or machine tap HSS-Co ¹⁾ (HSS, TiN, TiCN) ²⁾	3 – 8	60 – 120	50 – 100	40 – 80	30 – 60	20 – 50

¹⁾ Results obtained with tools manufactured by Ferrotec, Bielefeld, Germany

²⁾ Results obtained with tools manufactured by Fette GmbH, Schwarzenbek, Germany

Cooling agent or lubricant: emulsion



Milling: DILLIMAX steels can be machined using tools made of high-speed steel (HSS, TiN, TiCN) and tools with indexable inserts.

Please note that flame cutting edges may show a considerably higher degree of hardness.

The initial cut should thus be at least 2 mm deep, i.e. sufficiently far below the hardened heat-affected zone. Indexable inserts are sensitive to vibrations.

Therefore, all possible measures must be adopted to reduce vibrations, e.g. firm clamping of the workpiece. If large surfaces

need to be processed, it is advisable to machine the plate alternately on both sides, since this helps reduce the distortion of the workpiece while milling.

Recommendations for the cutting speed and feed rate for face and edge milling are given in Table 11.

Table 11: Recommendations for face and edge milling of high strength DILLIMAX steels

DILLIMAX	Tool type (Cutting material)	Cutting speed V_c [m/min]	Feed per tooth f_z [mm]
890	Face milling-/Roughing cutters (FC 220N) ¹⁾ (HC-P20 + TiN)	130 – 190	0.12 – 0.20
965	Face milling-/Roughing cutters (FC 220N) ¹⁾ (HC-P20 + TiN)	120 – 180	0.10 – 0.18

¹⁾ Results with tools manufactured by Fette GmbH, Schwarzenbek, Germany

Cooling agent or lubricant: none



THE COMPONENT PROPERTIES OF DILLIMAX

The most important characteristic is fatigue strength. Weldable, fine grained structural steels in the upper strength range such as DILLIMAX 690 to DILLIMAX 1100 are preferred for components whose weight is to be kept to a minimum (e.g. constructions in the materials-handling and hoisting equipment sectors). The high tensile properties of DILLIMAX steels are particularly of advantage for constructions subjected to a low number of load cycles, and thus designed assuming quasi-static conditions (mobile cranes for instance). Cyclical loads during service life can be decisive for the design of a component.

DILLIMAX steels are strong against cyclical loading. However, welds are subjected to much higher fatigue than the base material, and can thus lead to component failure. When using DILLIMAX steels, particular attention must therefore be paid to the quality of the welding and its subsequent treatment in order to exploit the high strength of the steel.

Primary importance shall be attached to minimizing the notch effect originating from the welded joints, because the behaviour of the weld is heavily dependent on the stress concentration factor resulting from the weld geometry.



*Figure 20: Mobile crane assembling a tower crane
(Illustration used with the kind permission of Liebherr-Werk
Ehingen GmbH, Ehingen, Germany)*



Figure 21 shows the Wöhler scatter bands for V weld joints made of DILLIMAX steels. As the chart shows, the fatigue strength does not increase at the same rate as the yield strength.

In extreme cases, the upper-strength-range steels (DILLIMAX 890-965) even react more sensitively than the lower-strength steels (DILLIMAX 500-690) when subjected to a high number of stress cycles.

Improvements in the service life achieved by TIG-treatment

of the butt joints can be traced back to improved notch geometry (smoother transition between plate surface and seam cap pass), see Figure 22.

Application of the post-weld treatment methods TIG dressing and UIT (Ultrasonic Impact Treatment) lead to important improvements of the fatigue strength of welded constructions. Improvement of the fatigue strength through the UIT-method result essentially from the compressive internal stresses which are brought in

and also from the improvement of the notch configuration at the weld joint transition. With this method, very good results could be reached for DILLIMAX 690, s. Figure 23.

Table 12 shows how the service life of a structural component can be significantly lengthened by other methods of subsequent treatment of the welds. The values given are purely for informative purposes.



Figure 21: Wöhler scatter bands of welded joints made of DILLIMAX steels (10 % to 90 % fracture probability, V weld specimens, 60°, plate thickness 10 mm, R=0)

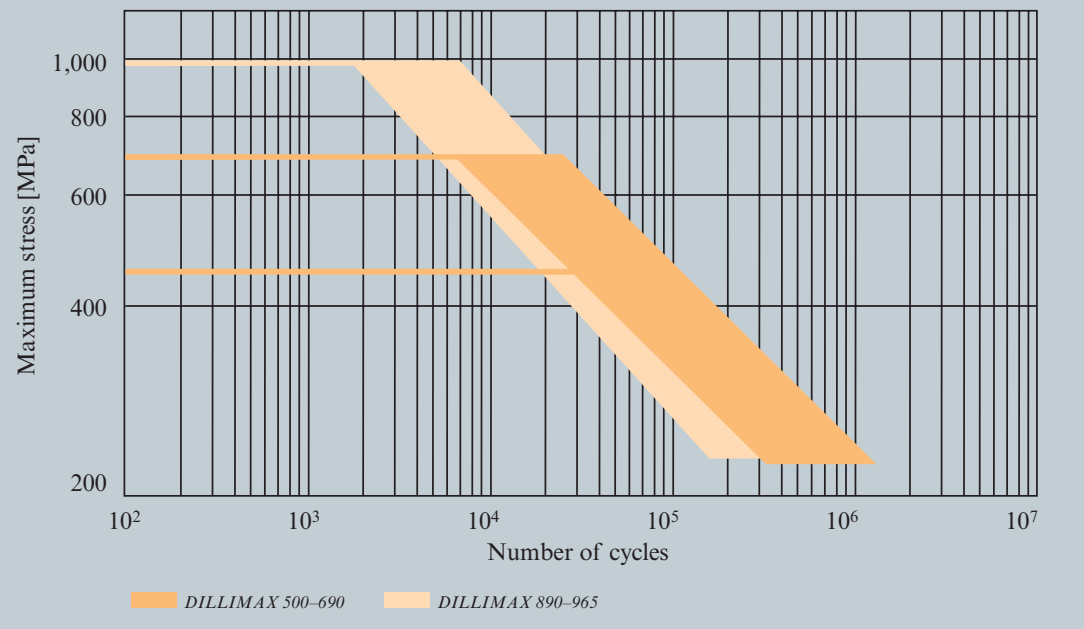




Figure 22: Influence of TIG treatment on the Wöhler scatter bands of welded joints made of DILLIMAX 890/965 (10 % to 90 % fracture probability, R=0)

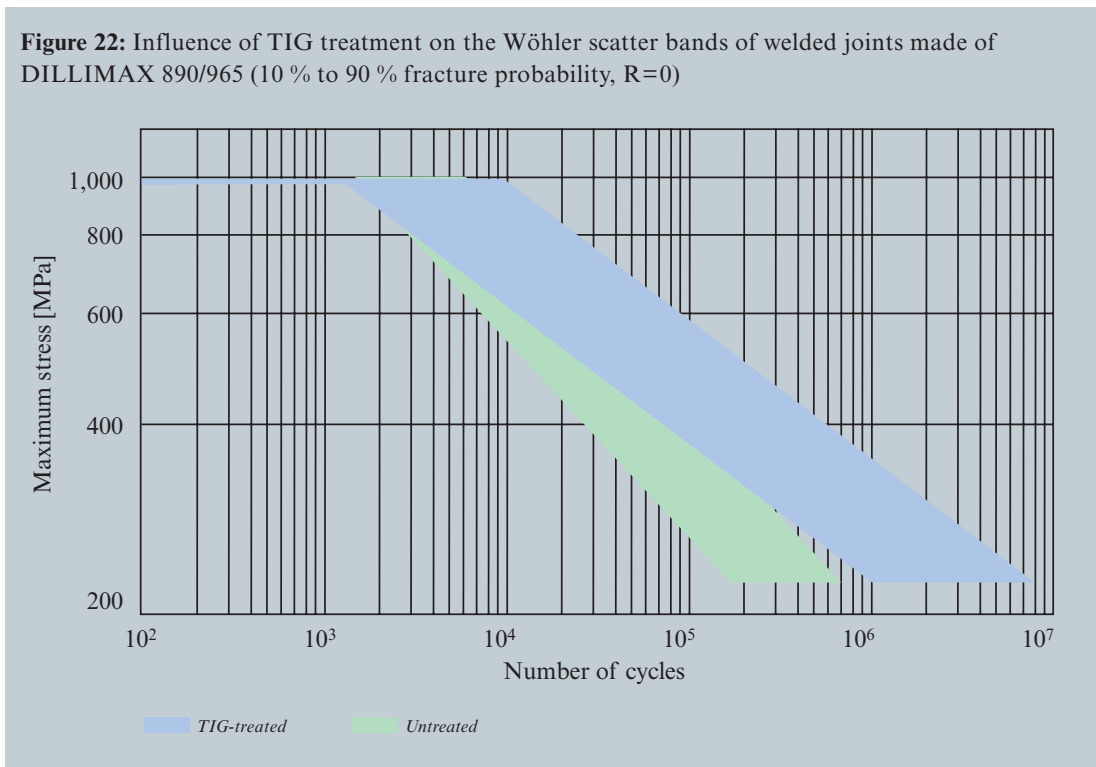




Figure 23: Influence of TIG- or UIT-treatment on the Wöhler curves of welded joints made from DILLIMAX 690 (small scale specimen, cross stiffener), from Fosta report P 620: “Fatigue strength improvement for welded high strength steel connections due to the application of post-weld treatment methods“

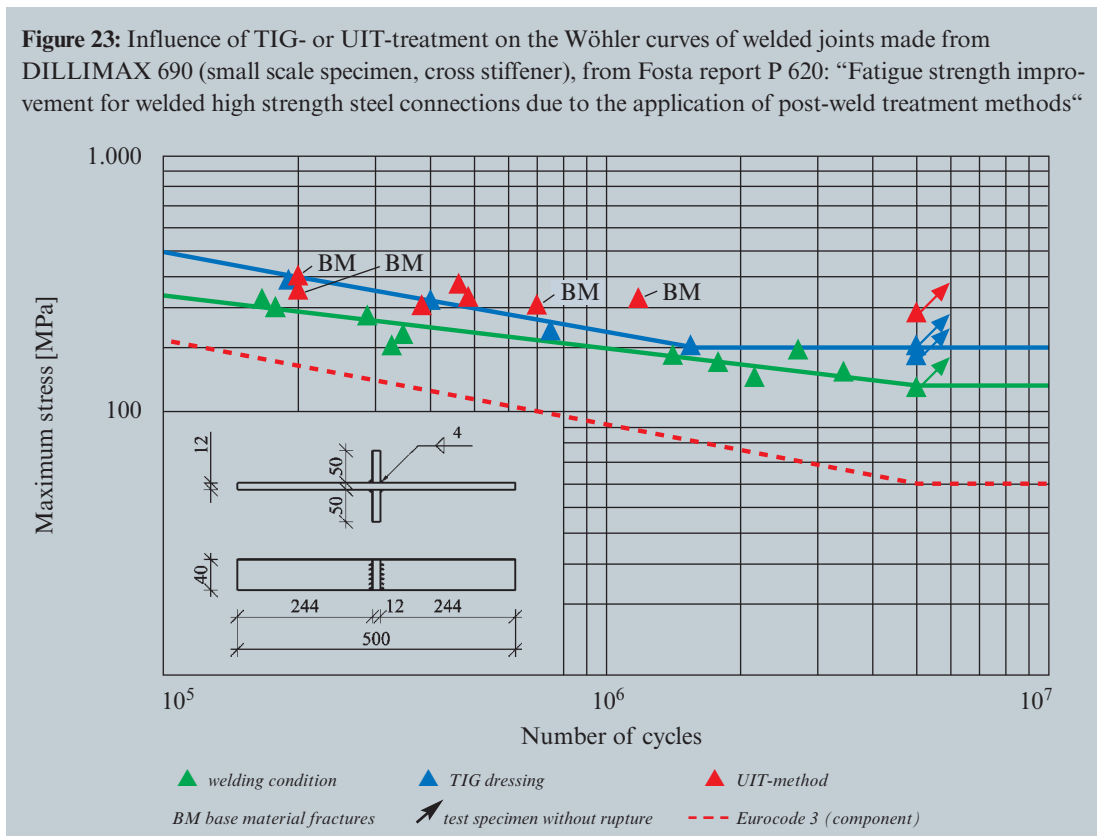




Table 12: Cyclical maximum stress in MPa of base materials and welded joints made of DILLIMAX steels after various subsequent treatments (50 % fracture probability – only for information)

Number of cycles	DILLIMAX 690		DILLIMAX 890		DILLIMAX 965	
	10 ⁵	2•10 ⁶	10 ⁵	2•10 ⁶	10 ⁵	2•10 ⁶
Base material	560	350	670	410	530	350
V weld without treatment	360	180	370	160	330	160
V weld with stress relieving	320	200	270	160	—	—
V weld with TIG dressing	490	290	470	235	450	210
V weld with TIG dressing and stress relieving	460	270	420	245	—	—
V weld with shot blasting	475	340	400	245	—	—
V weld with shot blasting and stress relieving	330	195	—	—	—	—
V weld with TIG dressing and shot blasting	420	300	—	—	—	—



LITERATURE

Additional reading for the section “Weight-Watching for your Steel Structures“

Auvigne J.F.: Un exemple industriel d’allègement par l’emploi des HLE: Cas des grues mobiles PPM, Tôles en acier HLE – Choix et mise en œuvre, Journées organisées par le CETIM, l’OTUA et le CNISF, 30 March 1994, pp. 57-63

Nimal F.: Participation des aciers HLE dans l’allègement des pièces mécaniques creuses faites à partir de tôles – Bilan économique, Tôles en acier HLE – Choix et mise en œuvre, Journées organisées par le CETIM, l’OTUA et le CNISF, 30 March 1994, pp. 65-75

EN 10025-6 (11/2004): Hot rolled products of structural steels – Part 6: Technical delivery conditions for flat products of high yield strength structural steels in the quenched and tempered condition, CEN

Allgemeine bauaufsichtliche Zulassung Nr. Z-30.1-1: Flacherzeugnisse aus hochfestem schweißgeeignetem Feinkornbaustahl S690QL1 und die daraus hergestellten Bauteile. Deutsches Institut für Bautechnik, Berlin, Januar 2005

prEN 1993-1-12: 2005 Eurocode 3: Design of steel structures – Part 1.12: Additional rules for the extension of EN 1993 up to steel grades S700, CEN, 2005

EN 10028-6 (06/2003): Flat products made of steels for pressure purposes – Part 6: Weldable fine grain steels, quenched and tempered, CEN

Additional reading for the section “The Processing of DILLIMAX“

Bouhelier C.: Le formage des tôles fortes, CETIM, 1982

EN 1011 (Part 1: 05/2002, Part 2: 01/2001): Recommendations for welding of metallic materials, CEN

Uwer D. et al.: Schweißen moderner hochfester Baustähle, Stahl u. Eisen 112 (1192) 4, pp. 29-35

Thiele W.-R.: Gefüge von hochfesten Feinkornbaustählen nach Flammrichtvorgängen. Linde AG Sonderdruck 114. Linde AG Werksgruppe-Technische Gase, Höllriegelskreuth



Osama A. K.: Flammrichten von schweißgeeigneten Vergütungsstählen mit niedrigem Kohlenstoffgehalt, Schweißen und Schneiden 35 (1983) 5, pp. 216-219

Nieß M. et al.: Auswirkungen des Flammrichtens auf die mechanischen Güterwerte von hochfesten Feinkornbaustählen. DVS-Berichte Band 112. DVS-Verlag, Düsseldorf, 1988

Beratung Feuerverzinken:
Arbeitsblätter "Feuerverzinken",
Institut Feuerverzinken GmbH,
Düsseldorf, 1996

**Additional reading for the section
"The Component Properties of
DILLIMAX"**

Ring M. et al.: Fatigue properties of laser-beam weldments on high strength steels, Steel Research 65 (1994) 11, pp. 505-510

Fischer F. et al.: Rißeinleitungs- und Rißausbreitungswiderstand hochfester Baustähle bei statischer Beanspruchung, Stahl und Eisen 114 (1994) 11, pp. 125-128

Hübner P. et al.: MAG-Schweißverbindungen des Stahls StE 885 bei statischer, dynamischer und zyklischer Beanspruchung, Stahl und Eisen 115 (1195) 7, pp. 81-86

Hübner P. et al.: Schwingfestigkeit der hochfesten schweißbaren Baustähle StE 885 und StE 960. Dissertation. Technische Universität Freiberg, 1996

Franke S. et al.: Einfluß von Strukturparametern auf statische und zyklische Bruchzähigkeitskennwerte. Bericht EUR 16782 DE. Technische Forschung Stahl, 1994

U. Kuhlmann, A. Dürr,
J. Bergmann, R. Thumser: Effizienter Stahlbau aus höherfesten Stählen unter Ermüdungsbeanspruchung. Forschungsvorhaben P 620. Forschungsvereinigung Stahlanwendung e.V., 2006



INDEX

Ageing	15ff
Bending radius	12ff
Carbon equivalent	6
Cold cracking, liability to	23, 28f
Cold forming	12ff
Composition, chemical.....	6
Cooling time	23ff
Countersinking	36
Die opening	12ff
Drilling	35
Fatigue properties	38ff
Filler metals	21f
Flame cutting	17ff
Flame straightening	33
Elongation	8f
Galvanizing	34
Gas shielded metal arc welding.....	21f, 30ff
Heat-affected zone	17f, 20
Heat input (per unit length of weld)	23ff
High-temperature strength	11
Hot forming.....	16f
Impact energy	9, 15
Laser cutting	20
Manual arc welding	21, 30ff
Milling	37
Preheating temperature, minimum	18, 30ff
Plasma arc cutting	20
Renewed quenching and tempering	16f
Residual stress	28f, 37
Sawing	36
Stress relieving	16f, 33
Submerged arc welding	21f
Tapping	36
Tempering	7, 16f
Tensile strength	8f
Through-thickness direction, properties in	11
Water quenching	7
Weldability	21ff
Yield strength	8



SALES ORGANISATIONS

Germany

Vertriebsgesellschaft
Dillinger Hütte GTS
Postfach 104927
70043 Stuttgart
Tel: +49 7 11 61 46-300
Fax: +49 7 11 61 46-221

France

DILLING-GTS Ventes
5, rue Luigi Cherubini
93212 La Plaine Saint Denis
Cedex
Tel: +33 1 71 92 16 74
Fax: +33 1 71 92 17 98

Other countries

For your local representative
please contact our coordination
office in Dillingen:

Tel: +49 68 31 47 23 85
Fax: +49 68 31 47 99 24 72



AG der Dillinger Hüttenwerke

P. O. Box 1580
66748 Dillingen/Saar
Germany
Tel: +49 68 31 47-21 46
Fax: +49 68 31 47-30 89

e-mail: info@dillinger.biz
<http://www.dillinger.de>

General note (liability):
Any information given about the characteristics or possible use of materials and products only constitutes a description. Any assurances concerning the existence of specific properties or suitability for a specific purpose always require a special written agreement.



How to find us

